



General Specifications for STURDY Road Guard Range

- All products are manufactured from a highly visible natural white or red coloured UV stabilised polyethylene plastic with a density of 942kg/m³
- All products have a nominal wall thickness of 3mm.
- Each product can link into the next using a hole and spigot arrangement that creates a system with absolutely no gaps between each unit.
- Each product weighs less than all recommended manual handling lifting limits.
- The Road Guard has a unique stacking feature with locating lugs and receivers which allow every second, inverted unit to stack securely into the next.
- Each product has a number of holes to ensure that they cannot be overfilled with liquid.
- Products can incorporate a hot foil stamp serial number to ensure product traceability.
- Each product is manufactured with radii of 10mm to ensure no sharp corners.
- Forklift slots allow for the lifting of the road guard unit.
- Each road guard has a panel to allow for customer signage, available on request only.

384 - A: Road Guard

Total Road Coverage: 2000 mm

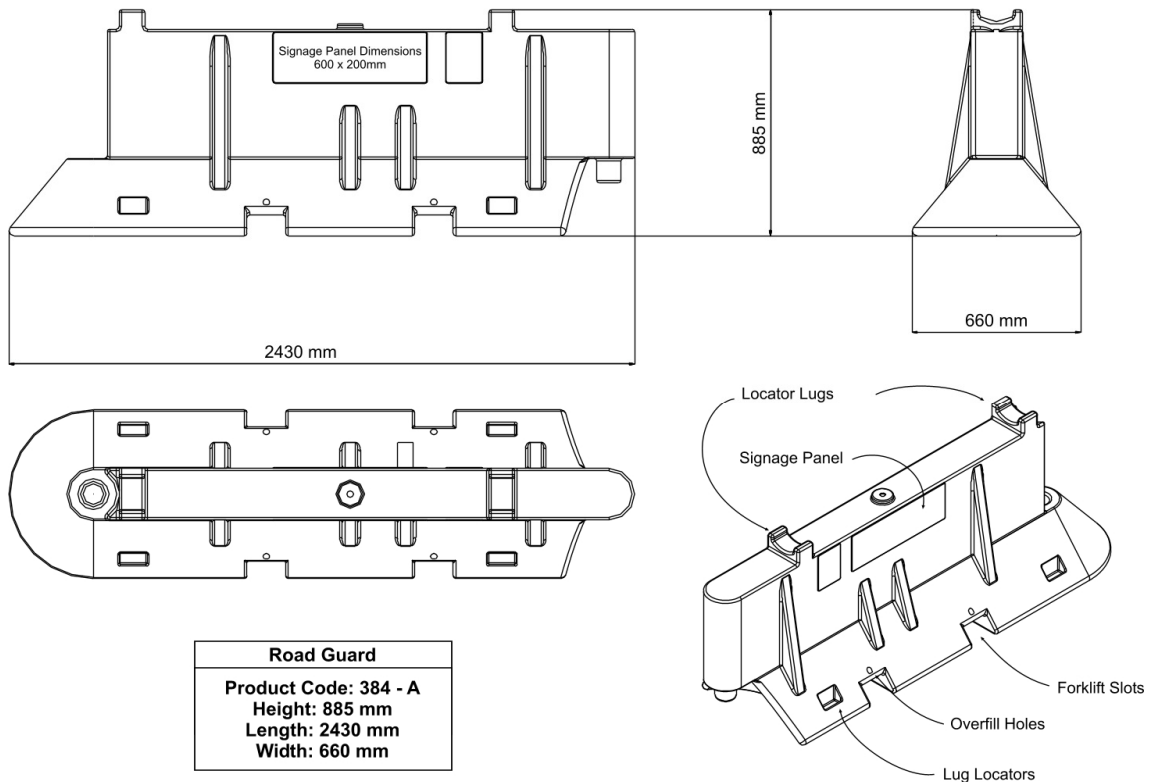

385 - A: Starter Road Guard

Total Road Coverage: 315 mm

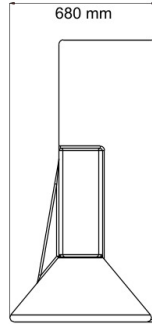
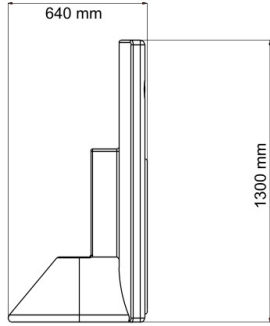

Starter Road Guard

Product Code: 384 - A
Height: 885 mm
Length: 2430 mm
Width: 660 mm

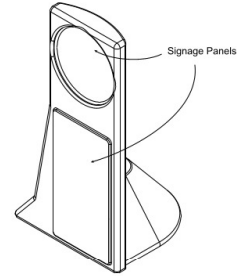

387 - A: Intermediate Road Guard

Total Road Coverage: 705 mm

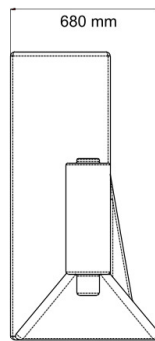
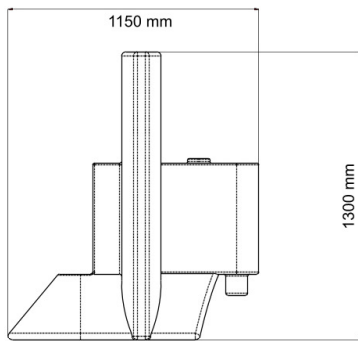

Intermediate Road Guard

Product Code: 384 - A
Height: 885 mm
Length: 2430 mm
Width: 660 mm

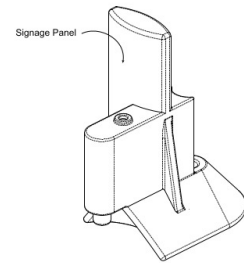

386 - A: End Road Guard

Total Road Coverage: 730 mm

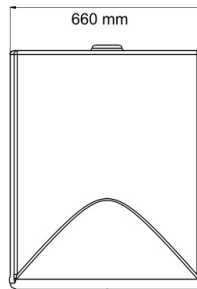
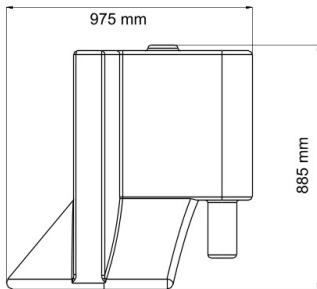

End Road Guard

Product Code: 384 - A
Height: 885 mm
Length: 2430 mm
Width: 660 mm

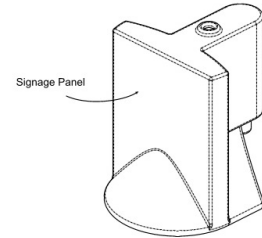

391 - A: Direction Invertor

An optional extra that allows for the change of direction of the system.
Total Road Coverage: 210 mm

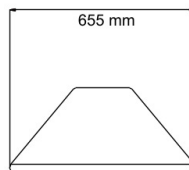
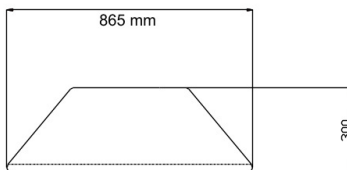

Direction Invertor

Product Code: 391 - A
Height: 885 mm
Length: 2430 mm
Width: 660 mm

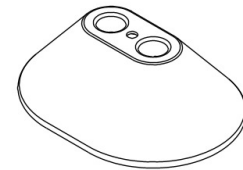

STURDY PRODUCTS LIMITED

Tel: 045 865044 Email: sales@sturdyproducts.com